



COOLINGFAN

35 10
mm

Axial Fan



常用规格 (General Specification:)

- ◆外框 (Frame) : PBT OF UL 94V-0
- ◆扇叶 (Impeller) : PBT OF UL 94V-0
- ◆轴承型号 (Bearing Type) : Sleeve Bearing & Ball Bearing & Hydro Bearing
- ◆引线 (Lead Wires) : UL Type or Equivalent (+) : Red (-) : Black
- ◆马达保护 (Motor Protection) : Reverse Polarity Protected; Automatic Restart
- ◆工作温度和湿度 (Operating Temperature and Humidity) : -10°C~70°C, 5%~90%RH
- ◆储存温度和湿度 (Storage Temperature and Humidity) : -40°C~80°C, 5%~95%RH

风扇性能曲线 (Fan Performance Curve)

尺寸 (Dimensions) (Unit:mm)

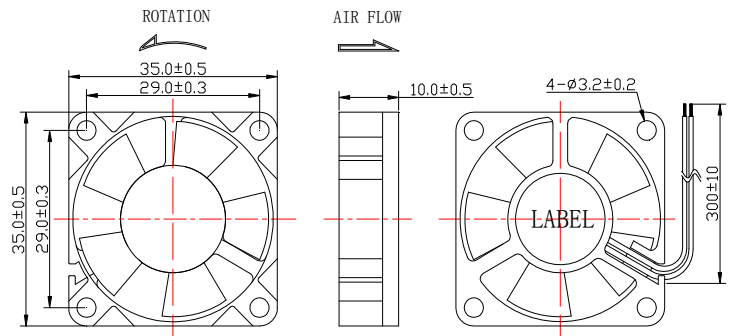
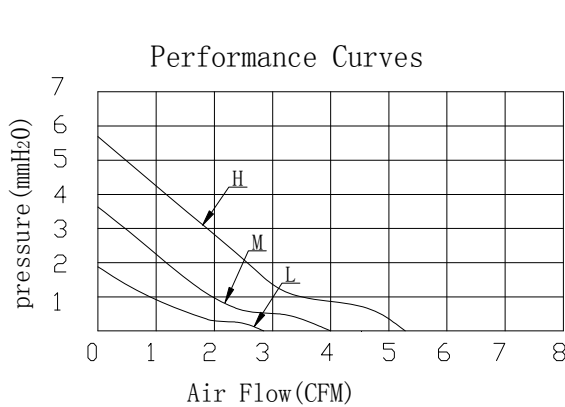

规格 (Specifications)

型号 Listed Model	额定电压 Rated Voltage	工作电压 Operating Voltage	额定电流 Rated Current	转速 Rated Speed	风量 Air Flow	风压 Static pressure	噪音 Noise Level	可选功能 Available Features (Optional)				重量 Weight
	(VDC)	(VDC)	(A)	(RPM)	(CFM)	(mmH ₂ O)	(dBA)	转速侦测 Tachometer Output	锁机报警 Rotation Detector	温控 Thermal Control	脉冲调速 Pulse Width Modulation	g
DFX351005H	5	3.5~5.75	0.25	9,000	5.20	5.70	33.40	◆	◆		◆	10
DFX351005M		3.5~5.75	0.18	7,000	4.00	3.50	26.90	◆	◆		◆	
DFX351005L		3.5~5.75	0.15	5,000	2.90	1.80	18.10	◆	◆		◆	
DFX351012H	12	6.0~13.8	0.15	9,000	5.20	5.70	33.40	◆	◆		◆	
DFX351012M		6.0~13.8	0.10	7,000	4.00	3.50	26.90	◆	◆		◆	
DFX351012L		6.0~13.8	0.08	5,000	2.90	1.80	18.10	◆	◆		◆	

X=S:Sleeve Bearing or B: Ball Bearing or H:Hydro Bearing ; Specifications are subject to change without notice

